



# MMS100

## Wireless Connectivity System Installation Manual

**NOTE:** Your Mighty Mule gate operator should be installed prior to setting up the MMS100 Wireless Connectivity System.

### AT THE GATE - INSTALLING THE RADIO MODULE

Prior to any assembly of the MMS100, ensure that the Mighty Mule gate operator is turned OFF and disconnected from its power source.

- 1 If required, punch out the access hole for the Auxiliary Antenna.
- 2 Align the connectors, then plug in the small radio module into the operator control board.
- 3 Guide the radio module antenna cable through the Auxiliary Antenna hold, then twist and tighten the antenna pointing upward.

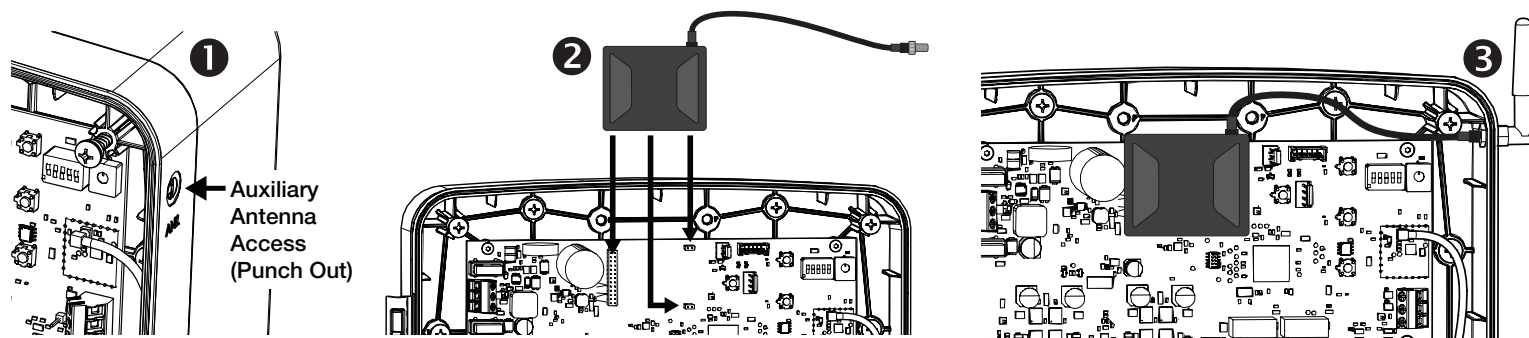

### WiFi ROUTER - Setting Up and Provisioning The Bridge

1. Install/locate the bridge near your wireless router.
2. Connect the Antenna and plug in the Bridge.
3. Plug in the MMS100 (only one gate operator can be connected to your Bridge).
4. To pair/connect the MMS100 to your WiFi:
  - a) Download the Mighty Mule App from the **Apple App Store** or **Google Play Store**.
  - b) Create a Mighty Mule account, then sign in.
  - c) Select **Add Device** on the home screen.
  - d) Select **Gate** from the pop-up menu, then follow the instructions in the App (or refer to the quick start guide for your specific model at [www.mightymule.com](http://www.mightymule.com)).

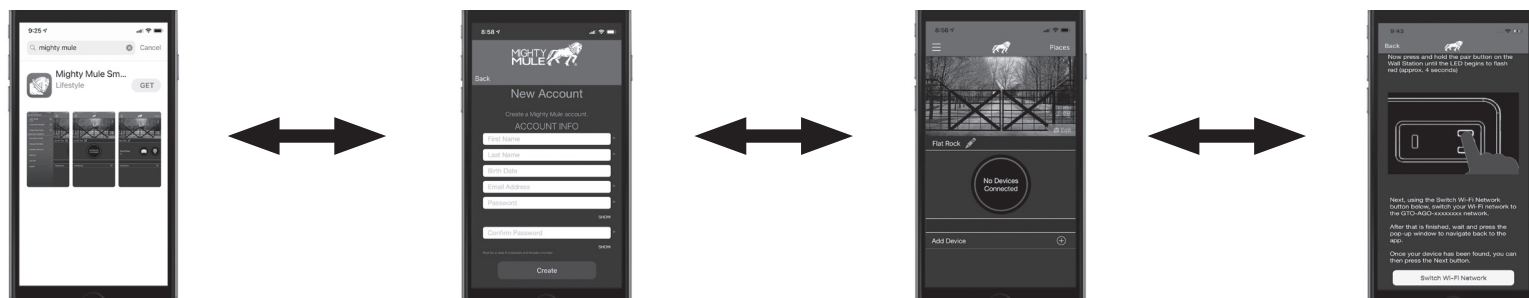
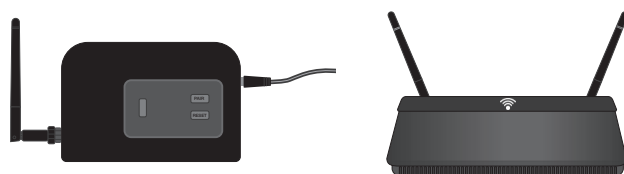

Displayed Mighty Mule App images are Apple iOS. The Android app interface will be slightly different.

## Establishing Communication Between the Bridge and your Mighty Mule Gate Operator (with radio module installed)

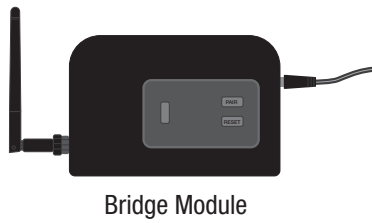

**NOTE:** The radio module and the bridge module are paired at the factory. They will attempt to connect after the unit is provisioned.

## Establishing Communication Between the Bridge and Your Mighty Mule Gate Operator

1. Communication between the Control Board (with radio module) and Bridge Module will automatically attempt to connect.
2. The LED should be flashing blue as it attempts to connect to the Gate Operator.
3. Wait approximately 5 minutes to see if your system will connect within the “Low” power level setting.
4. If the light does not turn green, the power level setting will need to be adjusted.

### To Adjust the Power Level Settings:

**CAUTION:** Do not set the power level setting to “Medium” or “High” if your Bridge Module and the Radio Module are within **25 ft of each other**.

If the Bridge Module and Radio Module (Control Box) are far enough apart that a connection does not occur after 5 minutes of powering up the unit (the green LED on the Bridge Module does not turn solid), then the power level will need to be adjusted. The following steps will need to be taken:

**NOTE:** The power level will need to be adjusted on both the Control Board and the Bridge Module using the **Mighty Mule App**.

1. Stand next to the gate operator control box.
2. Open the control box and adjust the power level.
  - a. Hold down **S3** for 10 Sec. A visual indication of the current power level setting will be given via the number of lit LEDs (1 for **Low**, 2 for **Medium** and 3 for **High**).
  - b. Adjust the power level up to **Medium** by pressing the **S2** button.
    - i. S2 increases the power level setting.
    - ii. S4 decreases the power level setting.
3. Adjust the power level for the Bridge using the Mighty Mule App.
  - a. Go to the app **Device Details** page.
  - b. Click on the Power Level button (should currently be indicating **Low**).
  - c. Select **Medium** (which needs to align with the setting that was set on the control board).
4. Stand next to your Bridge Module, then wait 5 minutes to ensure that the LED on the Bridge Module turns solid green.
5. If the LED on the Bridge Module does not turn green after 5 minutes, repeat steps 1-4 in order to change the power level to **High**.

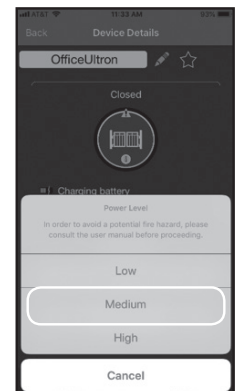
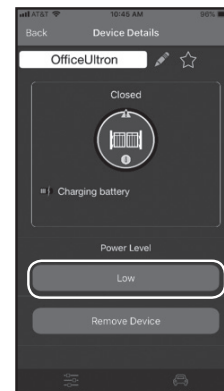
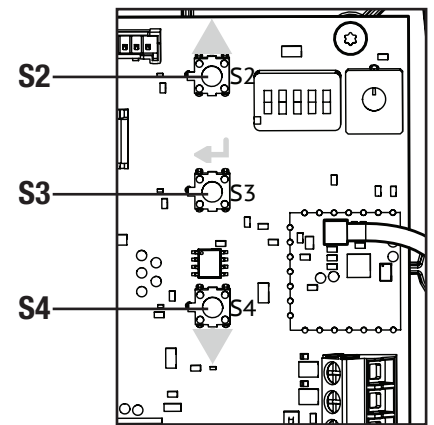

Displayed Mighty Mule App images are Apple iOS. The Android app interface will be slightly different.

## LED Indication Lights and Status

| LED Indication Lights |            | Status  |
|-----------------------|------------|---|
| Color                 | State      |   |
| Green                 | Solid      | Connected to router, server & AGO. Normal status.   |
| Green                 | Flashing   | Connected to router. Not connected to server.       |
| Yellow                | Flashing   | Obtaining IP  |
| Red                   | Solid      | Offline. No access point.                           |
| Red                   | Slow Flash | Not connected to access point.                      |
| Red                   | Fast Flash | User initiated pairing via App.                     |
| Pink                  | Flashing   | Connecting and/or checking OTA.                     |
| Pink                  | Solid      | OTA in process.                                     |
| Blue                  | Flashing   | Connected to router & server. Not connected to AGO. |

## FCC & IC Notice

We, Nortek Security & Control, LLC of 5919 Sea Otter Place, Carlsbad, CA 92010, declare under our sole responsibility that the device, MMS100 complies with Part 15 of the FCC rules.

This device complies with Part 15 of the FCC Rules and Industry Canada license exempt standard(s). Operation is subject to the following two conditions:

- (1) This device may not cause harmful interference, and
- (2) This device must accept any interference received, including interference received that may cause undesired operation.

Le présent appareil est conforme aux CNR d'Industrie Canada applicables aux appareils radio exempts de licence. L'exploitation est autorisée aux deux conditions suivantes:

- (1) l'appareil ne doit pas produire de brouillage, et
- (2) l'utilisateur de l'appareil doit accepter tout brouillage radioélectrique subi, même si le brouillage est susceptible d'en compromettre le fonctionnement.

This Class B digital apparatus complies with Canadian ICES-003

Cet appareil numérique de la classe B est conforme à la norme NMB-003 du Canada.

This equipment has been tested and found to comply with the limits for a Class B digital device, pursuant to Part 15 of the FCC Rules. These limits are designed to provide reasonable protection against harmful interference in a residential installation.

This equipment generates, uses, and can radiate radio frequency energy and, if not installed and used in accordance with the instructions may cause harmful interference to radio communications. However, there is no guarantee that interference will not occur in a particular installation. If this equipment does cause harmful interference to radio or television reception, which can be determined by turning the equipment off and on, the user is encouraged to try to correct the interference by one or more of the following measures:

- Reorient or relocate the receiving antenna.
- Increase the separation between the equipment and receiver
- Connect the equipment into an outlet on a circuit different from that to which the receiver is connected
- Consult the dealer or an experienced radio/TV technician to help.

### WARNING:

- Changes or modifications not expressly approved by the party responsible for compliance could void the user's authority to operate the equipment.
- Only use this equipment with the provided antenna's, failure to do so will void the user's authority to operate the equipment.
- This system is for use the Mighty Mule Smart Capable Gate Operator (Model(s): MM371, MM372, MM571, MM572, TS571)
- A minimum separation distance of 20 cm (or possibly greater than 20 cm) between the antenna and nearby persons should be maintained.



Telephone Mighty Mule Sales: 1-800-543-4283 • Fax (850) 575-8912  
or Mighty Mule Technical Service: 1-800-543-1236 • Fax (850)575-8950  
[www.mightymule.com](http://www.mightymule.com)